

# SPx RadarWatch

Situational awareness for coastal and maritime security

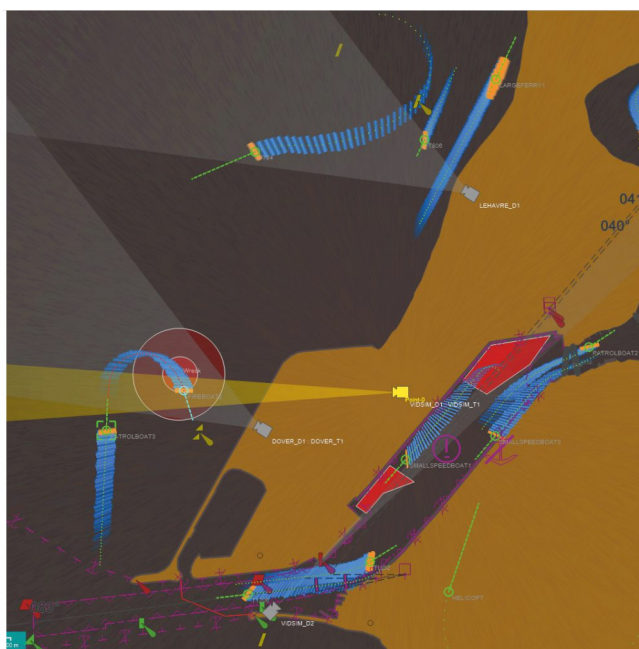
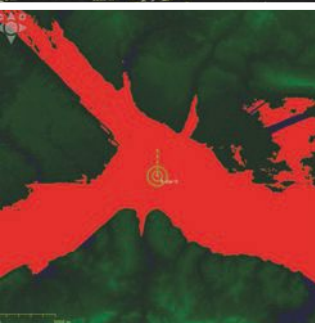
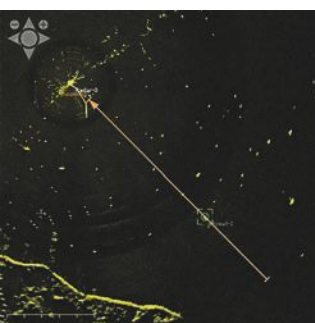

# RadarWatch

Cambridge Pixel's RadarWatch is a flexible situational awareness display for maritime applications, maritime and coastal surveillance and simple vessel traffic monitoring. It provides an integrated presentation of radar video, tracks, camera data, AIS, mapping and alarm processing, offering a powerful, flexible and cost-effective maritime information system. RadarWatch works with a wide range of radar sensors and cameras, allowing system integrators to specify the right sensor for each application.

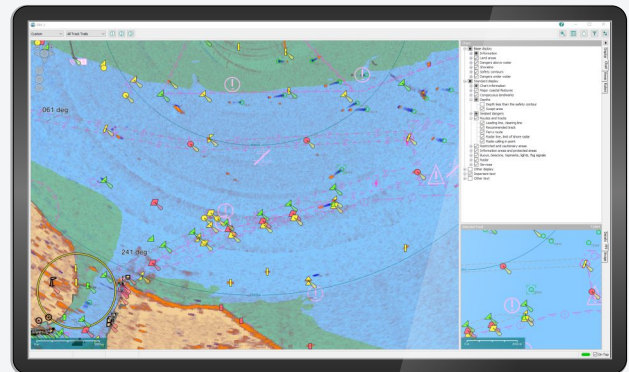
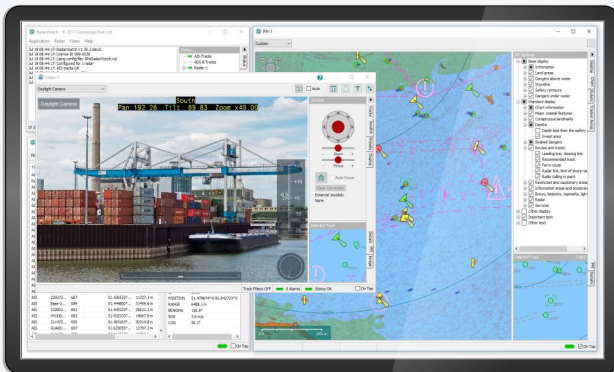
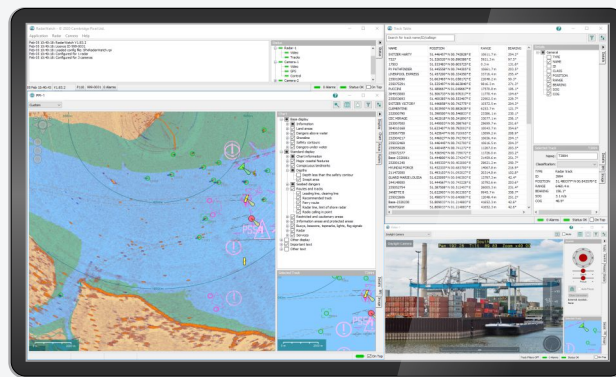

RadarWatch can accept data from up to 4 radars and up to 16 cameras. Radar data is presented in a number of clear multi-layer PPI display windows that may be freely moved and resized. Radar video is drawn over tiled maps or S-57 format electronic charts (with support for S-63 encryption). Received primary, fused, AIS and ADS-B tracks are presented as a graphical overlay on top of the radar video and map layers.

Camera videos are displayed in a configurable "multiview" window, as an M-by-N grid. Any of the camera videos may be easily selected for display in a separate window. Video windows may be freely moved and resized. RadarWatch integrates camera control using the Pelco-D and ONVIF control protocols and includes slew-to-cue functionality. This allows a target of interest to be selected from a PPI window and followed automatically using the most suitable camera available.

# System Configuration

RadarWatch is designed to work with related software components from Cambridge Pixel, including:

- SPx Server for target tracking
- SPx Fusion Server for fusion of primary tracks, AIS and ADS-B
- RDR for data recording and replay
- SPx Camera Manager to control multiple cameras from multiple clients

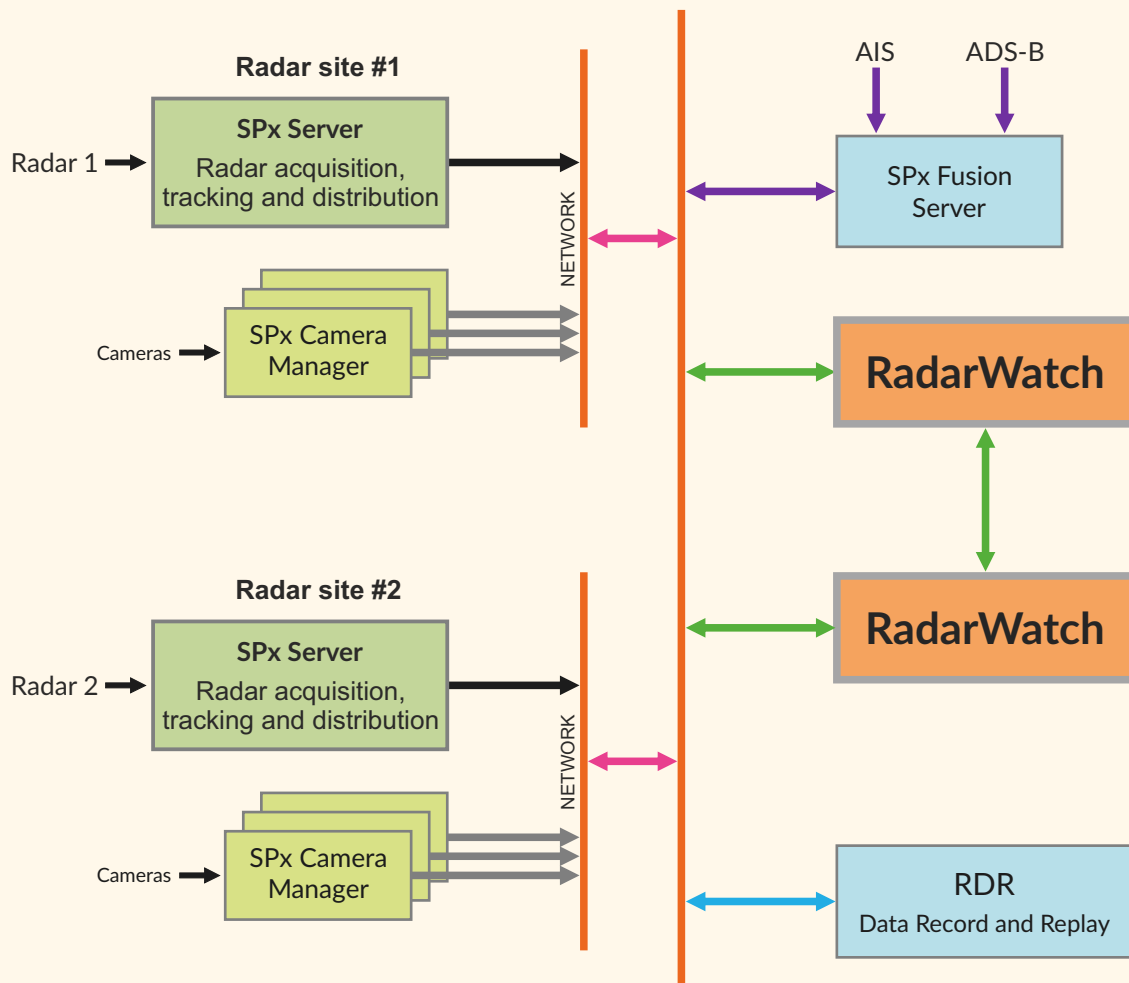

A typical system will comprise several radar locations, each with an SPx Server to receive radar video from the sensor and extract tracks. SPx Fusion Server can combine tracks from overlapping sensors with reports from AIS, ADS-B or IFF to ensure a single, consistent track label is used for each target. Radar tracks (both per-sensor and fused) and video can be sent to RadarWatch for display.

The SPx Camera Manager permits up to 16 cameras to be controlled using a priority-based access method.

Multiple RadarWatch displays have access to the cameras and can display the video. However, a user must request access to a specific camera for PTZ

control purposes and this may be granted by the camera manager.

Cambridge Pixel's RDR Data Recorder provides the capability to capture and record sensor data (radar video, camera), tracks (AIS, ADS-B, radar tracks), audio and computer screens. All data is time-stamped and synchronised, permitting replay of both the original sensor data and what the operator could see on the computer monitor.

For use on tethered platforms, own ship NMEA navigation data is employed to accommodate own ship movements.

# Graphical Controls

Key features of the SPx RadarWatch GUI:

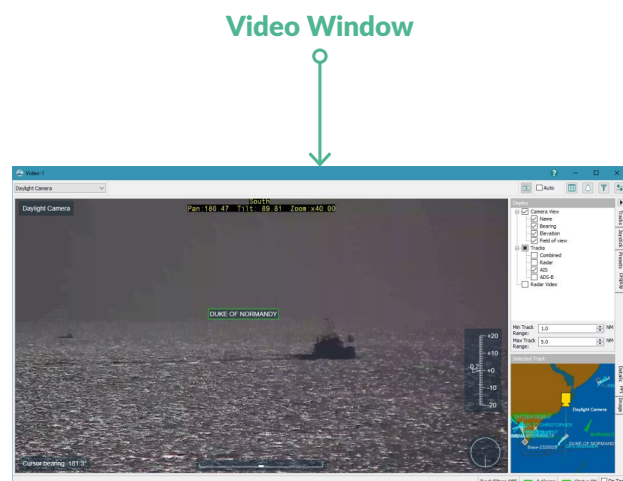
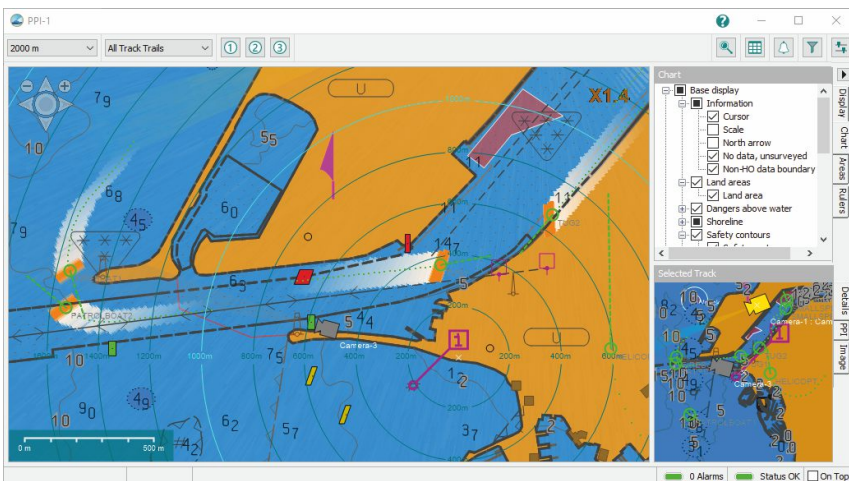
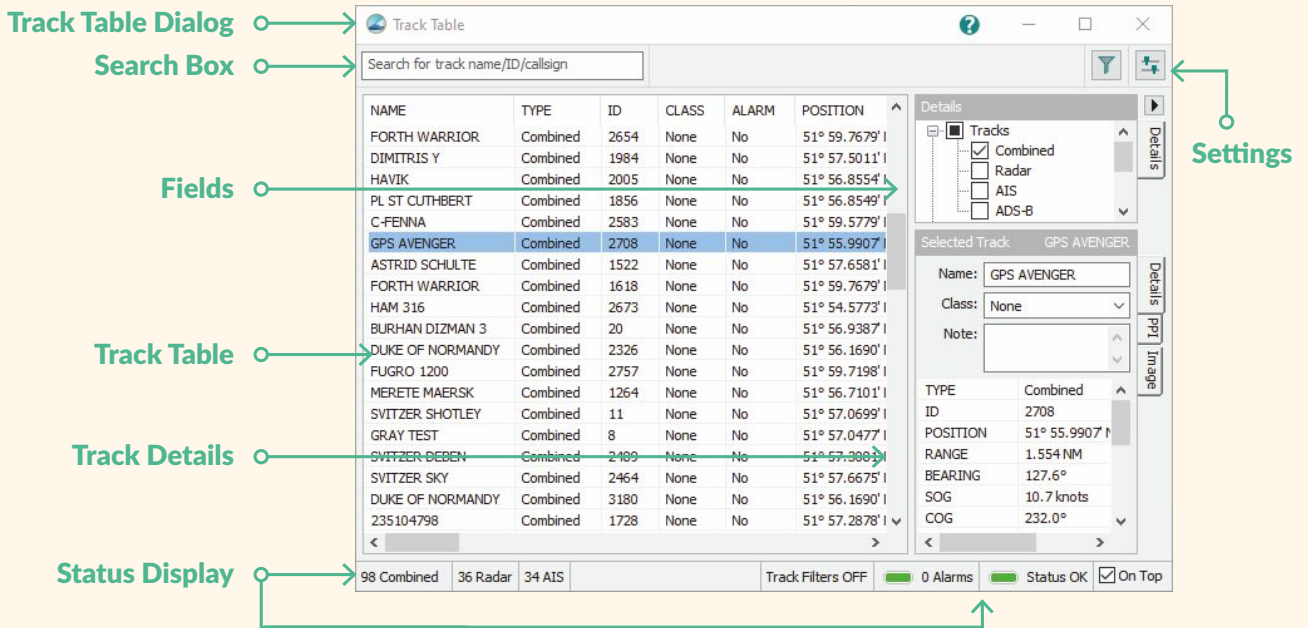
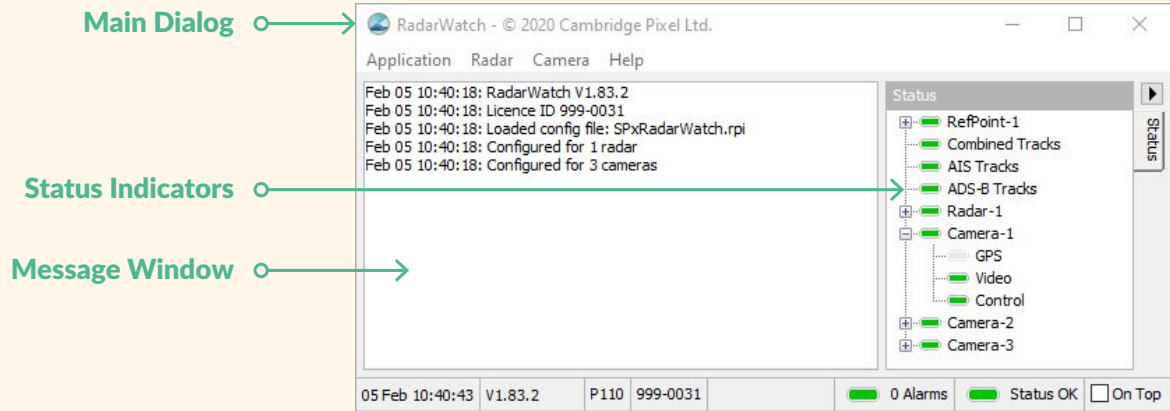

Large PPI Display

PPI Window

Settings & Controls

PPI Graphics Controls

ENC (S-57) Graphics

Target Markers

Track Label

Status

Track PPI/Details/Image



STATE	NAME	CONDITIONS
<input checked="" type="checkbox"/>	ZoneAlarm	1 Condition (NOT LEFT AREA)
<input checked="" type="checkbox"/>	HarbourGate1	1 Condition (GATE CLOSED)
<input checked="" type="checkbox"/>	HarbourGate2	1 Condition (GATE CLOSED)
<input checked="" type="checkbox"/>	ZoneAlarm	1 Condition (INSIDE AREA)
<input checked="" type="checkbox"/>	HarbourGate3	1 Condition (GATE CLOSED)

  

STATE	TIME	NAME	TRACK	OPA	TCPA	TRIGGERS
<input checked="" type="checkbox"/>	11 Feb 12:00:27	HarbourGate1	235001405			GATE CLOSED = HarbourGate1
<input checked="" type="checkbox"/>	11 Feb 12:00:55	HarbourGate2	SVITZER DEBEN			GATE CLOSED = HarbourGate2
<input checked="" type="checkbox"/>	11 Feb 12:01:30	ZoneAlarm	GPS AVENGER			INSIDE AREA = Zone2
<input checked="" type="checkbox"/>	11 Feb 12:02:23	ZoneAlarm	SALOE			NOT LEFT AREA = Zone1
<input checked="" type="checkbox"/>	11 Feb 13:41:04	ZoneAlarm	BURHAN DIZMAN 3			INSIDE AREA = Zone3

# Multi-screen, Multi-window

RadarWatch supports up to 4 display screens to show PPI display, camera videos, track table and alarm control windows. Windows can be resized and repositioned across one or several screens.

For situations preferring fixed window locations, the software can apply preset window configurations to automatically configure the windows to the preferred size and location. These window set-ups can be changed dynamically, permitting the software to support different modes of operation as situations change.

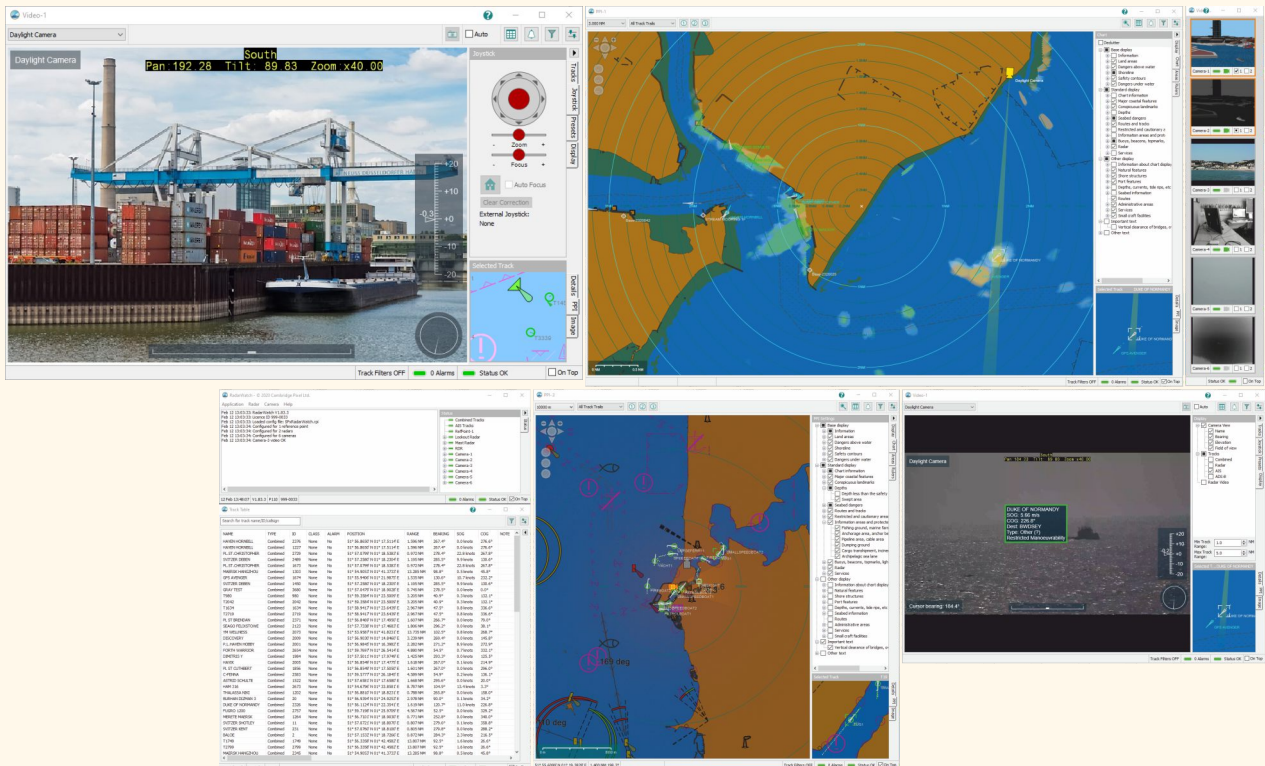

# Augmented Vision

RadarWatch supports Augmented Vision, which is the overlay of target information onto live video to aid interpretation of the scene.

The known location of targets, whether radar-derived or AIS-derived, is used to generate a graphical overlay for the camera video.

The position of the camera (pan, tilt and zoom) is used to predict where a target at a known range and bearing will appear.

The graphical symbology can include information relating to the target, for example the target's ID as reported from AIS, or the target's speed and course as derived from the primary radar processing. The ability to fuse radar and camera information in this way aids the interpretation of a complex scene.

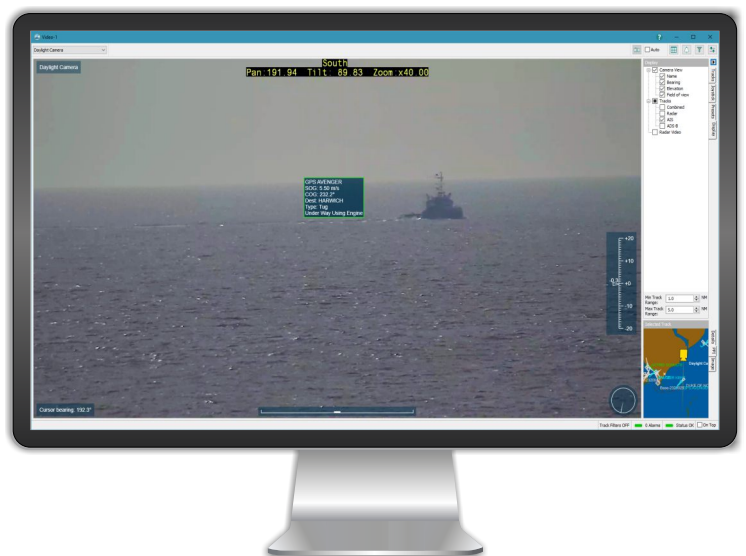

# Alerts

RadarWatch includes a comprehensive capability for defining alarms that occur on configurable events. Alarms can be triggered on targets entering, leaving or lingering within user-defined areas, targets passing through a controlled gate, or targets being in proximity to another target or to a reference point, or they can be triggered by AIS data (for example, cargo type). On an alarm event, the situation may be reported using visual or audible alarms (sounds for audible alarms can be configured), and/or by sending messages to other sub-systems and messages over the network (for example) to initiate recording.

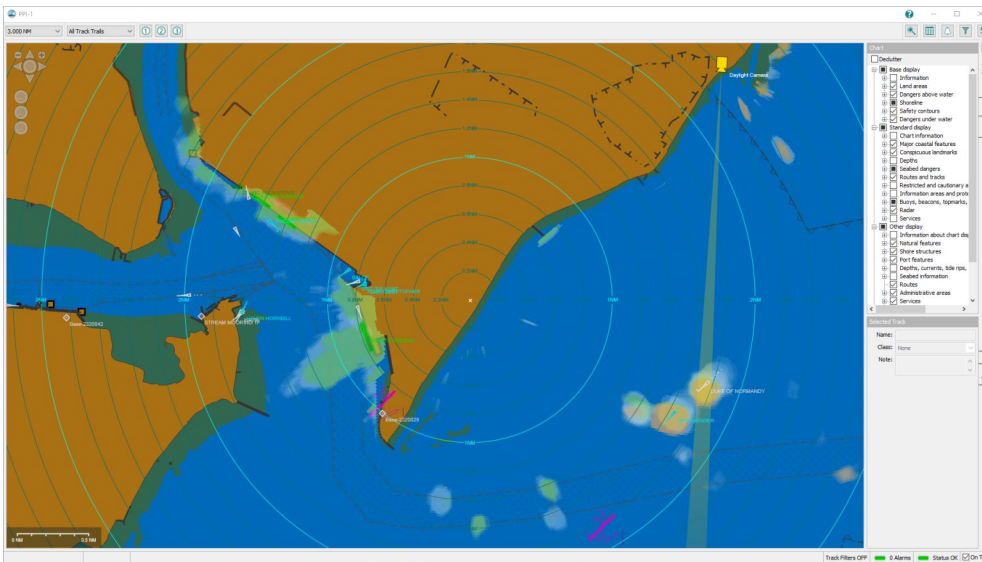

# Video Management

Multiple daylight and thermal cameras can be incorporated into RadarWatch.

The software provides pan-tilt-zoom (PTZ) control either directly to a camera, or indirectly through a Camera Manager, allowing multiple RadarWatch users to share access to multiple cameras.

The cameras can be controlled by a user through an on-screen joystick or may be controlled automatically from radar or AIS-derived tracks (slew-to-cue). This allows cameras to be automatically controlled based on incoming threats.

Camera Tours can be configured to permit cameras to automatically visit programmed locations.

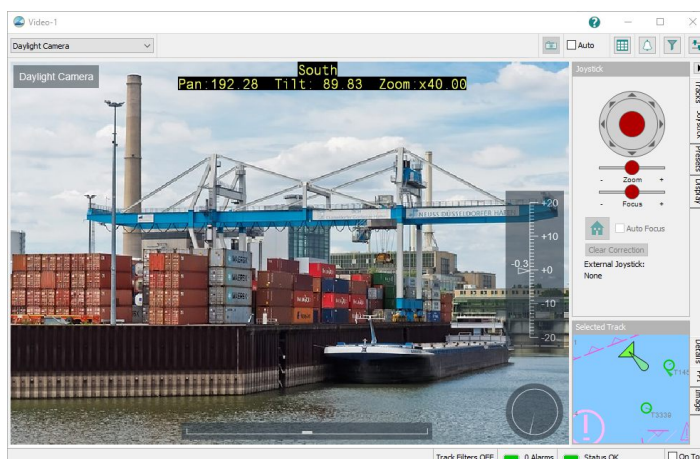



## Feature Summary

### Platform:

- Windows 10

### Display:

- Multiple screens with configurable window layout
- Multiple PPI displays with maps, primary radar, target symbols

### Inputs:

- Radar video - ASTERIX CAT-240 or SPx format (uses SPx Server to convert analogue radars to ASTERIX)
- Radar tracks ASTERIX CAT-48 or SPx format
- Camera video
- AIS (NMEA-0183)
- ADS-B (ASTERIX CAT-21)
- NMEA own platform navigation data

### Target tracking:

- Provided by external SPx Server (remote or local)
- Fully automatic track initiation. Manual initiation, repair, track deletion
- Multi-hypothesis, multi-model target tracker
- Configurable for different radar types, target types

### Track Display:

- Tracks displayed as overlay on map
- Track database with query
- Configurable track display with history
- Filter by type
- Search by name/callsign/ID

### Graphics:

- Loadable maps or S57/S63 charts (option)
- Target overlays
- Scan converted radar video
- Radar control

### Camera Control and Display:

- PTZ camera control direct to camera or through Camera Manager
- Camera position and state visualised on PPI
- Network or analogue camera supported
- Slew-to-cue to control camera from tracks
- Track labels overlaid on camera video
- Up to 16 cameras
- Tour configuration
- Interactive camera position/tilt correction/calibration

### Alerts:

- Comprehensive alert capability
- Alert on targets entering areas, target speeds and entering control gates
- CPA and TCPA based alerts
- Configurable geo-referenced alarm zones (simple or complex shapes)
- Alerts for lingering and leaving areas
- Safe list
- Alarms based on AIS data

### AIS:

- AIS input from network or serial
- AIS track display
- AIS fusion with primary tracks (SPx Fusion Server)

### Recording:

- Optional RDR software for integrated radar, camera, AIS, screen recording

### Other:

- Multi-language support
- Macro buttons
- Radar control
- Access control
- Support for common ADS-B dongles
- Shared access to alarm and area configurations
- Moving platform support
- Integration with ADS-B for air track monitoring
- RadarWatch as a remote server

## Typical Applications

RadarWatch is designed to provide a maritime display for small ports, harbours and coastal security applications. It can interface to a wide range of different radar sensors that are either local to the display or remote, and provides an integrated picture of radars, camera, maps and events.

### Applications include:

- Coastal Surveillance
- Port and harbour security
- Simple vessel traffic monitoring (VTS-lite)
- Search and rescue
- Oil and gas platform security
- Wind farm monitoring
- Firing range safety systems



THE QUEEN'S AWARDS  
FOR ENTERPRISE:  
INTERNATIONAL TRADE  
2015



New Cambridge House, Litlington  
Royston, Hertfordshire, SG8 0SS UK

T: +44 (0) 1763 852749  
E: [enquiries@cambridgepixel.com](mailto:enquiries@cambridgepixel.com)  
W: [cambridgepixel.com](http://cambridgepixel.com)  
@CambridgePixel